



EN Operating Instructionspages 1 to 6
Translation of the original operating instructions

Content

1 About this document

1.1 Function 1

1.2 Target group: authorised qualified personnel. 1

1.3 Explanation of the symbols used 1

1.4 Appropriate use 1

1.5 General safety instructions 1

1.6 Warning about misuse 2

1.7 Exclusion of liability 2

2 Product description

2.1 Ordering code 2

2.2 Special versions. 2

2.3 Destination and use 2

2.4 Technical data 2

2.5 Safety classification 2

3 Mounting

3.1 General mounting instructions 2

3.2 Dimensions 3

4 Electrical connection

4.1 General information for electrical connection. 3

4.2 Contact variants 3

4.3 Switch travel diagrams. 3

5 Set-up and maintenance

5.1 Functional testing. 4

5.2 Maintenance 4

6 Disassembly and disposal

6.1 Disassembly. 4

6.2 Disposal 4

7 Appendix

7.1 EC Declaration of conformity 5

1. About this document

1.1 Function
This operating instructions manual provides all the information you need for the mounting, set-up and commissioning to ensure the safe operation and disassembly of the switchgear. The operating instructions must be available in a legible condition and a complete version in the vicinity of the device.

1.2 Target group: authorised qualified personnel
All operations described in this operating instructions manual must be carried out by trained specialist personnel, authorised by the plant operator only.

Please make sure that you have read and understood these operating instructions and that you know all applicable legislations regarding occupational safety and accident prevention prior to installation and putting the component into operation.

The machine builder must carefully select the harmonised standards to be complied with as well as other technical specifications for the selection, mounting and integration of the components.

1.3 Explanation of the symbols used

 **Information, hint, note:**
This symbol is used for identifying useful additional information.

 **Caution:** Failure to comply with this warning notice could lead to failures or malfunctions.
Warning: Failure to comply with this warning notice could lead to physical injury and/or damage to the machine.

1.4 Appropriate use
The products described in these operating instructions are developed to execute safety-related functions as part of an entire plant or machine. It is the responsibility of the manufacturer of a machine or plant to ensure the correct functionality of the entire machinery or plant.

The safety switchgear must be exclusively used in accordance with the versions listed below or for the applications authorised by the manufacturer. Detailed information regarding the range of applications can be found in the chapter "Product description".

1.5 General safety instructions
The user must observe the safety instructions in this operating instructions manual, the country-specific installation standards as well as all prevailing safety regulations and accident prevention rules.

 Further technical information can be found in the Schmersal catalogues or in the online catalogue on the Internet: www.schmersal.net.

The information contained in this operating instructions manual is provided without liability and is subject to technical modifications.

 If multiple safety components are wired in series, the Performance Level to EN ISO 13849-1 will be reduced due to the restricted error detection under certain circumstances. The entire concept of the control system, in which the safety component is integrated, must be validated to EN ISO 13849-2.

There are no residual risks, provided that the safety instructions as well as the instructions regarding mounting, commissioning, operation and maintenance are observed.

x.000 / Dezember 2013 / v.A. - 101208965-EN / D / 2013-12-19 / AE-Nr. 3196

1.6 Warning about misuse



In case of inadequate or improper use or manipulations of the safety switchgear, personal hazards or damages to machinery or plant components cannot be excluded. The relevant requirements of the standard EN ISO 13850 must be observed.

1.7 Exclusion of liability

We shall accept no liability for damages and malfunctions resulting from defective mounting or failure to comply with this operating instructions manual. The manufacturer shall accept no liability for damages resulting from the use of unauthorised spare parts or accessories.

For safety reasons, invasive work on the device as well as arbitrary repairs, conversions and modifications to the device are strictly forbidden; the manufacturer shall accept no liability for damages resulting from such invasive work, arbitrary repairs, conversions and/or modifications to the device.

2. Product description

2.1 Ordering code

This operating instructions manual applies to the following types:

EX-T3Z 068-①YR

No.	Option	Description
①	11	1 NO contact / 1 NC contact
	22	2 NO contact / 2 NC contact
	33	3 NO contact / 3 NC contact



Only if the information described in this operating instructions manual are realised correctly, the safety function and therefore the compliance with the Machinery Directive and the Explosion Protection Directive is maintained.

2.2 Special versions

For special versions, which are not listed in the order code below 2.1, these specifications apply accordingly, provided that they correspond to the standard version.

2.3 Destination and use

Pull-wire emergency stop switches are used wherever it must be possible to initiate the emergency stop command from any point on a machine, equipment or plant. The emergency stop command is triggered by pulling on the tensioned pull-wire. The components can be used in explosion-endangered areas of Zone 21 and 22 equipment category 2D and 3D. The installation and maintenance requirements to the standard series EN 60079 (ABNT NBR IEC 60079) must be met.

The pull-wire Emergency Stop switch has wire-breakage monitoring. On pulling or breakage of the wire, the NC contacts are positively opened and the NO contacts are closed. The pull-wire Emergency Stop switch can then only be returned to the operational condition by a resetting operation.

2.4 Technical data

Equipment category:	⊕ II 2D
Ex protection:	Ex tb IIIC T90°C Db
INMETRO:	DNV 13.0077
Standards:	EN 60947-5-1, EN 60947-5-5, EN ISO 13850, EN 60079-0, EN 60079-31, ABNT NBR IEC 60947-5-1, ABNT NBR IEC 60947-5-5, ABNT NBR IEC 60079-0, ABNT NBR IEC 60079-31

Enclosure:	Grey cast iron, painted
Cover:	cast iron, enamel finish
Protection class:	IP 65, IP 66 to EN 60529 (ABNT NBR IEC 60529)
Contact material:	silver, gold-flashed
Contact type:	change-over contact with double break, max. 3 NO and 3 NC contacts
Switching system:	⊖ EN 60947-5-1 snap action, NC contacts with positive break
Max. impact energy:	7 J
Max. actuating speed:	1 ms
Max. surface temperature:	+90 °C
Termination:	Screw terminals
Cable section:	max. 1.5 mm ² , min. 0.75mm ² , solid and stranded wire with conductor ferrules
Cable entry:	2 × M20 × 1,5
U _{imp} :	4 kV
U _i :	250 V
I _{the} :	10 A
Utilisation category:	AC-15 / DC-13
I _e /U _e :	2.5 A / 230 VAC; 6 A / 24 VDC
Max. fuse rating:	6 A gG D-fuse
Required short-circuit current:	1000 A
Positive break torque:	1,8 Nm
Angle for positive break travel:	32°
Positive break force:	50 N
Actuating force:	max. 50 N (30 N in wire direction)
Ambient temperature:	-20 °C ... +60 °C
Mechanical life:	50.000 operations
Max. wire length:	2 × 50 m
Features:	wire pull and breakage detection
Cable glands:	⊕ II 2GD, 1,21 ABNT NBR IEC 60079
Cable cross-section:	min. Ø 7 mm; max. Ø 12 mm
Tightening force:	Cable gland: 8 Nm Blocking screws: 8 Nm Cover screws: 1 Nm

2.5 Safety classification

Standards:	EN ISO 13849-1
B _{10d} Opener (NC):	100.000
Service life:	20 years

$$MTTF_d = \frac{B_{10d}}{0,1 \times n_{op}} \quad n_{op} = \frac{d_{op} \times h_{op} \times 3600 \text{ s/h}}{t_{cycle}}$$

(Specifications can vary depending on the application-specific parameters h_{op} , d_{op} and t_{cycle} as well as the load.)

3. Mounting

3.1 General mounting instructions



Fitting is only authorised in a de-energised condition

The fitting may only be carried out by authorised personnel. The pull-wire emergency stop switch must be fitted in the middle of the plant. Four mounting holes are available. The use of a protective ground wire is imperative. Mount the pull-wire emergency stop switch so that the device can be unlocked and reset by hand after an emergency stop command. The pull wire must be installed according to the specifications (Fig. 1).

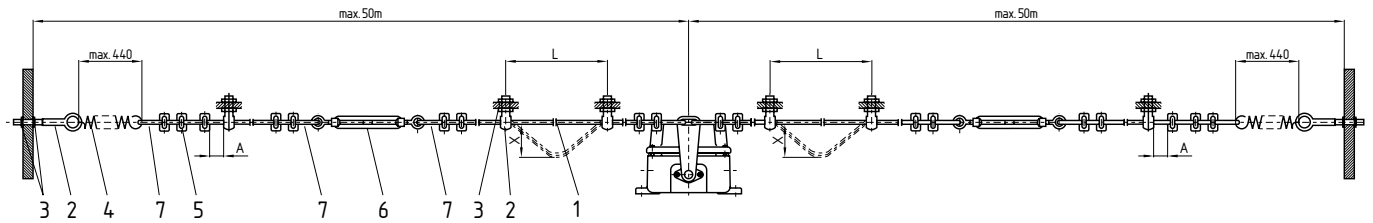

Figure 1

Accessories:

- ① Pull-wire with red PVC sheath Ø 5 mm (steel core: Ø 3 mm)
- ② Eyebolt
- ③ Nuts
- ④ Stainless steel tension spring
- ⑤ Wire clamp
- ⑥ Tensioner
- ⑦ Wire thimble

Switch travel x : approx. 400 mm (L = 3 m)
Stroke limitation A: 70 mm
Distance between support points: max. 3 m

Equip the pull wire ① at the connection points with a thimble ⑦ and two wire clamps ⑤. The first wire clamp must be installed immediately behind the thimble. The PVC sheet of the pull wire must be stripped in the thimble area. Adjust the pre-tension of the springs ④ by means of the tensioner ⑥ so that the lever is in the middle position and the counter-side triggers the emergency stop command in case of wire breakage of slack wire. Then set the stroke limitation of both springs to A = 70 mm by means of the eyebolt ② and the wire clamp.



Please observe the recommendations regarding maximum impact energy, actuating speed and tightening torque in the technical data.



Please observe that external influences (temperature variations, aging) could cause the pull wire to be altered.

3.2 Dimensions

All measurements in mm.

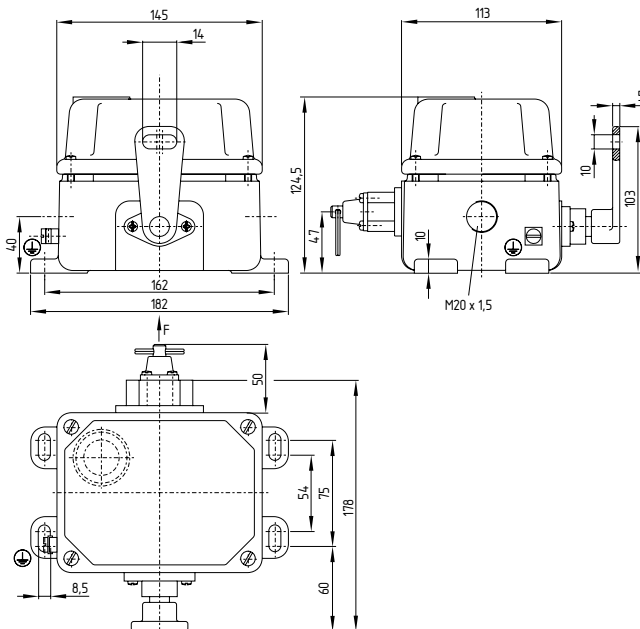

4. Electrical connection

4.1 General information for electrical connection



The electrical connection may only be carried out by authorised personnel in a de-energised condition.

Only use cable glands which are authorised for the corresponding field of application. The cable glands must be fitted in accordance with the applicable operating instructions manual. Cable glands are only authorised for permanent cables. The constructor must provide for the necessary strain relief. Unused cable entries must be sealed by means of Ex approved locking screws. Cable glands and locking screws are not included in delivery. After wiring, the cover screws must be tightened uniformly. Tightening torque: 1 Nm.

4.2 Contact variants

4.3 Switch travel diagrams

1 NO contact / 1 NC contact

EX-T3Z 068-11YR

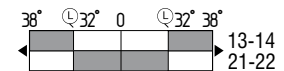
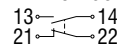

2 NO contact / 2 NC contact

EX-T3Z 068-22YR

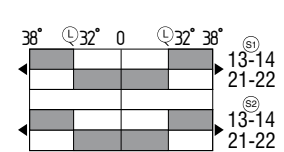
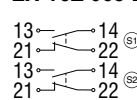

3 NO contact / 3 NC contact

EX-T3Z 068-33YR

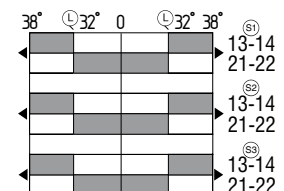
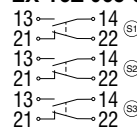

5. Set-up and maintenance

5.1 Functional testing

The safety function of the safety components must be tested. The following conditions must be previously checked and met:

1. The installation is executed according to the instructions
2. The connection is executed correctly
3. The cable is correctly executed and connected.
4. The safety component is not damaged
5. Check the free movement of the actuating element
6. Remove particles of dust and soiling
7. Check cable entry and connections in a de-energised condition

5.2 Maintenance

In case of correct installation in accordance with the above-described instructions, the component requires little maintenance. By use in extreme conditions, we recommend routine maintenance including the following steps:

1. Check the free movement of the actuating element
2. Remove particles of dust and soiling
3. Check the correct fixing of the cover screws
4. Check for damages and correct fixing
5. Check cable entry and connections in a de-energised condition



Do not open the device when live.

Damaged or defective components must be replaced. For explosion protection reasons, the component must be exchanged after max. 50,000 operations.

6. Disassembly and disposal

6.1 Disassembly

The safety switchgear must be disassembled in a de-energised condition only.

6.2 Disposal

The safety switchgear must be disposed of in an appropriate manner in accordance with the national prescriptions and legislations.

7. Appendix

7.1 EC Declaration of conformity

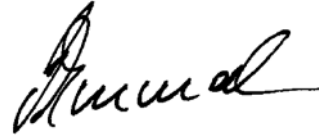
	
<h2>EC Declaration of conformity</h2>	
Translation of the original declaration of conformity	K.A. Schmersal GmbH & Co. KG Industrielle Sicherheitssysteme Möddinghofe 30, 42279 Wuppertal Germany Internet: www.schmersal.com
We hereby certify that the hereafter described safety components both in its basic design and construction conform to the applicable European Directives.	
Name of the safety component / type:	EX-T3Z 068 ⊕ II 2D Ex tb IIIC T90°C Db
Description of the safety component:	Pull-wire emergency stop switch for safety applications.
Relevant EC-Directives:	2006/42/EC-EC-Machinery Directive 94/9/EC EC-Explosion Protection Directive (ATEX)
Used harmonized standards:	EN 60947-5-1, EN 60947-5-5, EN ISO 13850, EN 60079-0, EN 60079-31
Person authorized for the compilation of the technical documentation:	Oliver Wacker Möddinghofe 30 42279 Wuppertal
Notified body, which approved the full quality assurance system, referred to in Appendix X, 94/9/EC:	TÜV Rheinland Industrie Service GmbH Am Grauen Stein, 51105 Köln ID n°.: 0035, Certification-n°.: 01 220 4316/02
Notified body:	DEKRA EXAM GmbH Dinnendahlstraße 9, 44809 Bochum ID n°.: 0158
EC-prototype test certificate:	BVS 08 ATEX E 156
Place and date of issue:	Wuppertal, September 17, 2012
EX-T3Z 068-C-EN	
	Authorised signature Philip Schmersal Managing Director



The currently valid declaration of conformity can be downloaded from the internet at www.schmersal.net.



K. A. Schmersal GmbH & Co. KG
Industrielle Sicherheitssysteme
Möddinghofe 30, D - 42279 Wuppertal
Postfach 24 02 63, D - 42232 Wuppertal

Phone: +49 - (0)2 02 - 64 74 - 0
Telefax +49 - (0)2 02 - 64 74 - 1 00
E-Mail: info@schmersal.com
Internet: <http://www.schmersal.com>